

# DAKAR

DUAL SPORT KITS



*KLX400 DUAL SPORT KIT INSTALLATION*



## KIT CONTENTS

### Inspect Your Kit

Your kit will include the following items

#### A. KLX400 Instructions

Read through the entire instruction manual before starting.

#### B. Dakar Headlight Assembly

#### C. Handlebar Turn Switch

#### D. Horn

#### E. Tail Light and Mounting Screws

#### F. Universal Hardware Bag (Contents)

-Turn Signals (4)

-Brake Light Switches (1)

-Cable Ties

-Wiring Diagram Label

-Round Plastic Signal Alignment Wedges

#### G. Main Wiring Harness

#### H. Mounting Kit Hardware Bag

-Triple Clamp Mounting Brackets

-Kit Specific Pieces

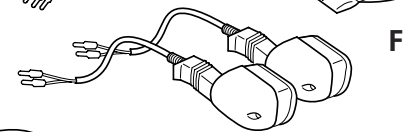
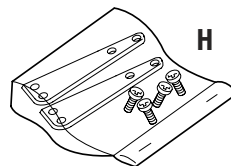
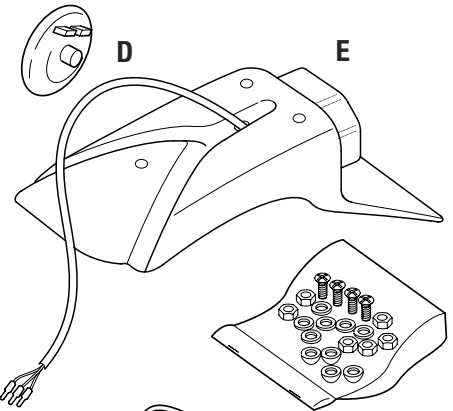
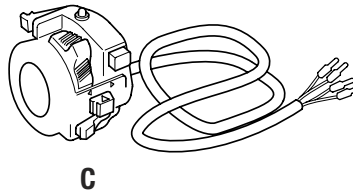
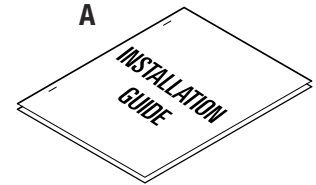
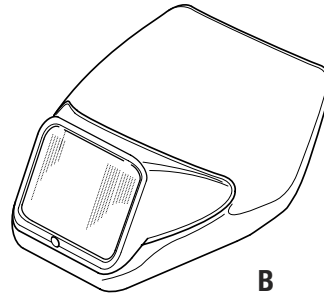

Turn Signals

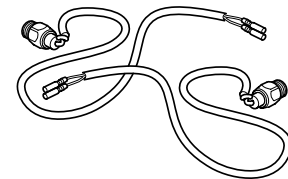
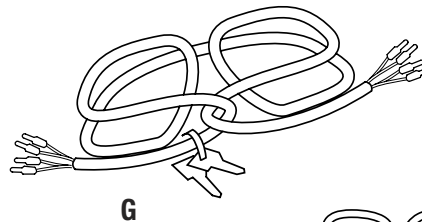

Brake Light Switch

*Note: Please take a moment to become familiar with the contents of the kit. Due to slight variances between motorcycle models, there may be differences in the instruction manual drawings and the actual parts. The basic installation procedure remains the same.*

### HEADLIGHT MOUNTING BRACKETS AND TURN SIGNALS

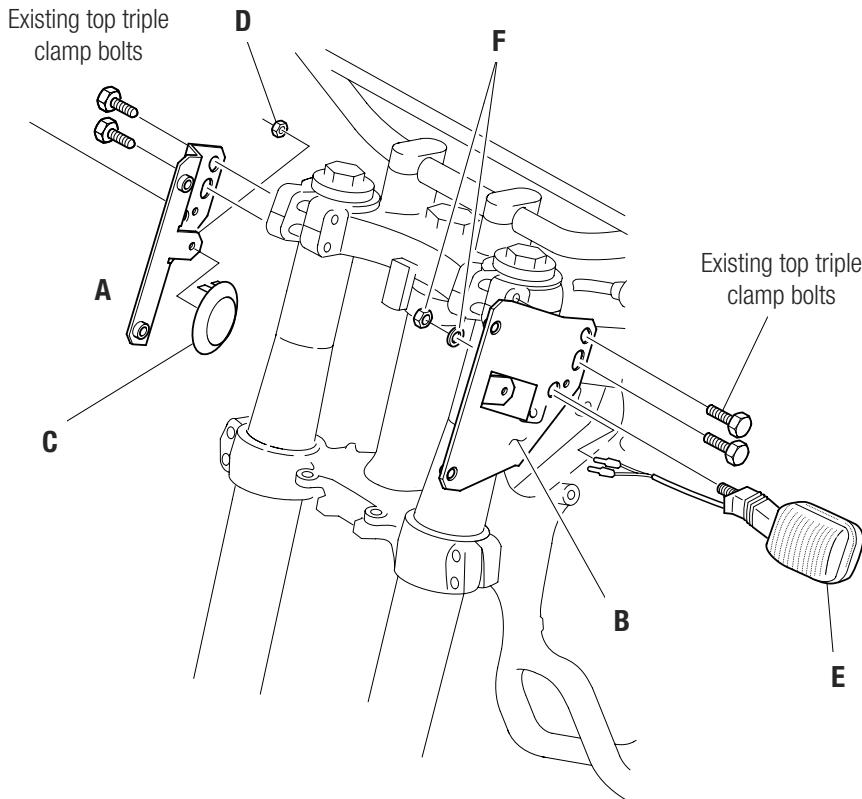

#### Headlight Mounting Brackets

Remove and retain existing top triple clamp bolts. Position headlight mounting brackets (A and B) and loose fit the existing triple clamp bolts at this time.

#### Horn Installation

There is a nut (D) which is installed on the horn (C) mounting stud. Remove nut and locate horn onto mounting tab on right side headlight bracket (A) as shown. Make sure the horn's two wiring connection spades face up. Secure horn (D) with nut previously removed.

#### Attaching Turn Signals

Insert turn signal (E) and threaded stud with wiring through headlight bracket turn signal mounting hole. Note: There is a small locator hole directly next to the turn signal mounting hole which is used to position the signal into the headlight bracket. Loose fit, washer and nut (F) on signal. Repeat for opposite side.

## HEADLIGHT WIRING

### Headlight Wiring Connection

From the Dakar wiring harness, plug-in the headlight connector into the new headlight assembly.

From the Dakar wiring harness, connect the BROWN male lead into the ORANGE female lead that is within the previously removed headlight wiring connector. (See Illustration Below)

### Horn Bracket

Attach the horn bracket onto the lower tab of the headlight with one screw as shown. Note: The lip of the bracket should nest against the upper edge of the tab as shown.

### Horn Wiring Connection

From the turn switch wiring harness, connect the PINK and BLUE leads, into either of the horn spade connectors.

### Turn Switch Wiring Connection

Plug-in turn switch wiring harness connector into the main wiring harness white block connector. Be sure to fully seat the connection. You will hear the connector click into position on both the top and bottom sides. (Not shown in illustration)

### Turn Signal Wiring Connection

Connect both BLACK tail turn signal grounds into the dual BLACK female ground connector. From wiring harness connect the ORANGE female into the LIGHT BLUE male (right turn signal) connector, and the PINK female, into the LIGHT BLUE male, (left turn signal) connector.

### Brake Light Switch Wiring

From the main wiring harness, connect the VIOLET and BROWN female connectors into the front brake light switch male connectors. (Not shown in illustration)

### Note

Be sure to carefully and fully seat all connectors.

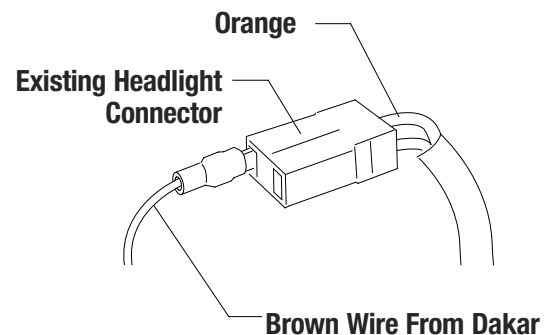
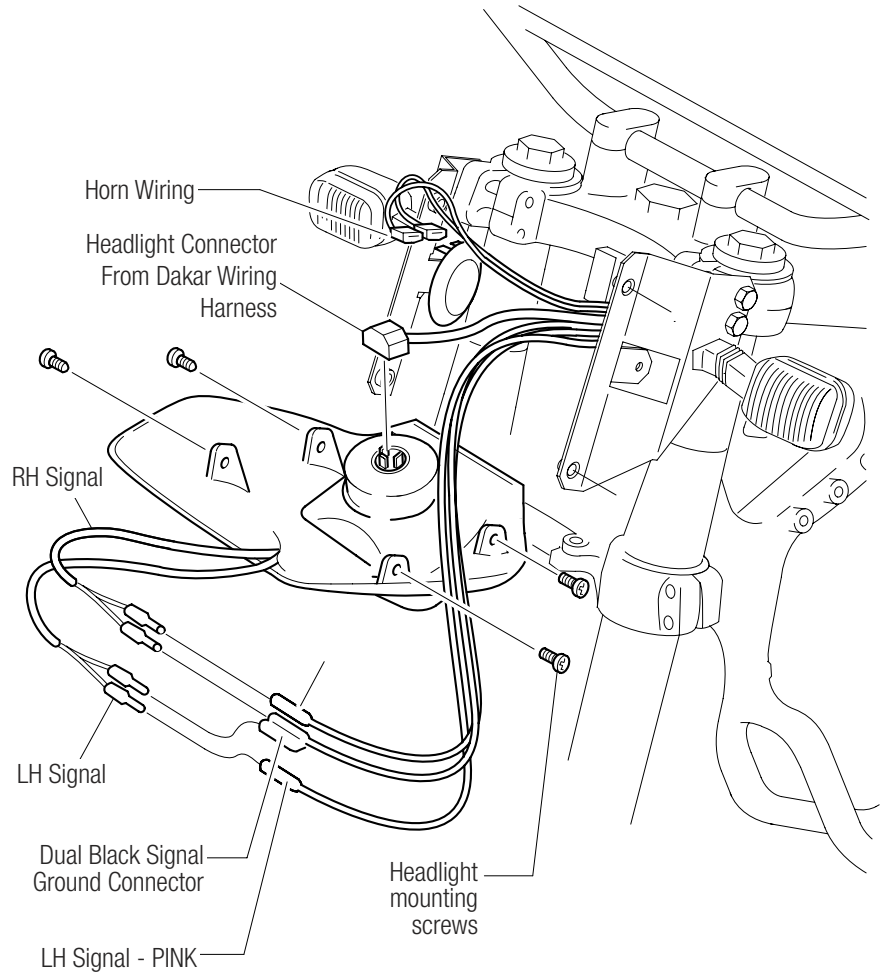

## TURN SWITCH INSTALLATION

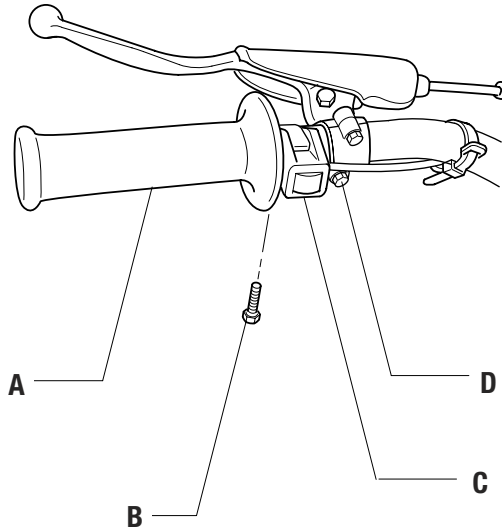

### Remove Existing Kill Switch

#### Step 1

Using a small phillips head screwdriver, loosen the locking screw ( B ) on the kill switch ( C ). Remove any cable ties and unplug kill switch from existing wiring. Retain kill switch wiring for modification.

#### Step 2

Loosen clutch cable perch ( D ) and move inboard about 1/2 inch.

### Install Turn Switch

#### Step 1

Open and wrap the new turn switch ( E ) around handlebar and securely fasten with two screws ( F ) as shown.

#### Step 2

Route turn switch wiring down and along handle bar behind Dakar headlight unit and in through frame cable guide. Secure switch wiring to handlebars with one cable tie. For more information, please refer to the Cable Routing Diagram.

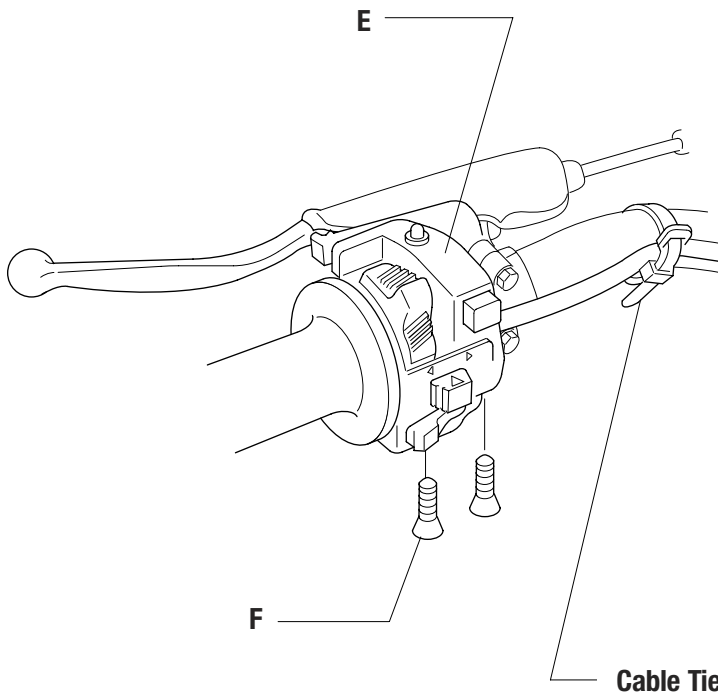

## BRAKE LIGHT SWITCH

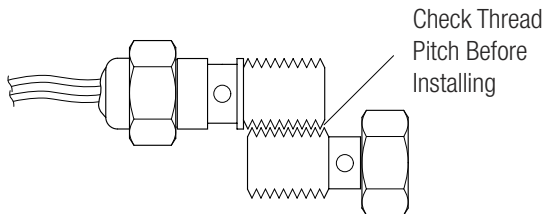

### **WARNING: Check the thread pitch on your banjo bolts**

*Make sure the thread pitch on your stock banjo bolts match the replacement versions provided in the kit. More than likely they will match. Some manufactures have changed the stock design requirement which is why it necessary to check. If your parts do not match up, stop the installation and give us a call. We'll send replacement parts to you!*

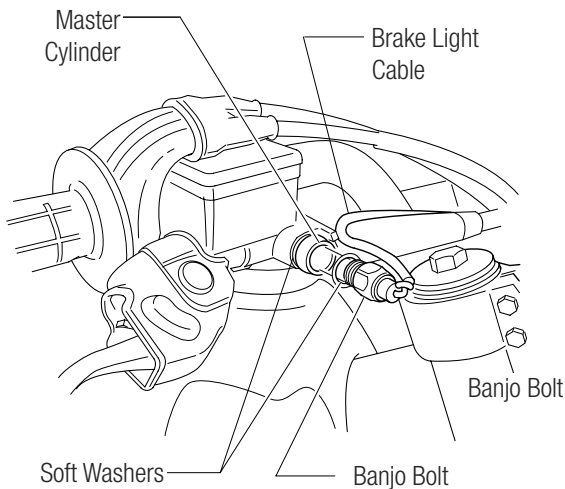

### **Front Brake Switch (For Taillight)**

#### **WARNING**

*Bleed front brake according to instructions provided in your owners or service manual. This must be performed in order for proper brake operation. Failure to do so may result in brake failure*

#### **Step 1**

Place a drop cloth or rag under the front brake and bike to catch any fluids. Loosen and retain banjo bolt on master cylinder.

#### **Step 2**

Insert brake light switch into position and fasten with banjo bolt on top of soft washer, hydraulic line and second soft washer. Securely fasten banjo bolt without stripping.

#### **Step 3**

Route the front brake light switch wiring along the lower portion of the handlebar towards the center of the triple clamps. Fasten wiring to the handlebar with a cable tie.

## TAILLIGHT AND TURN SIGNALS

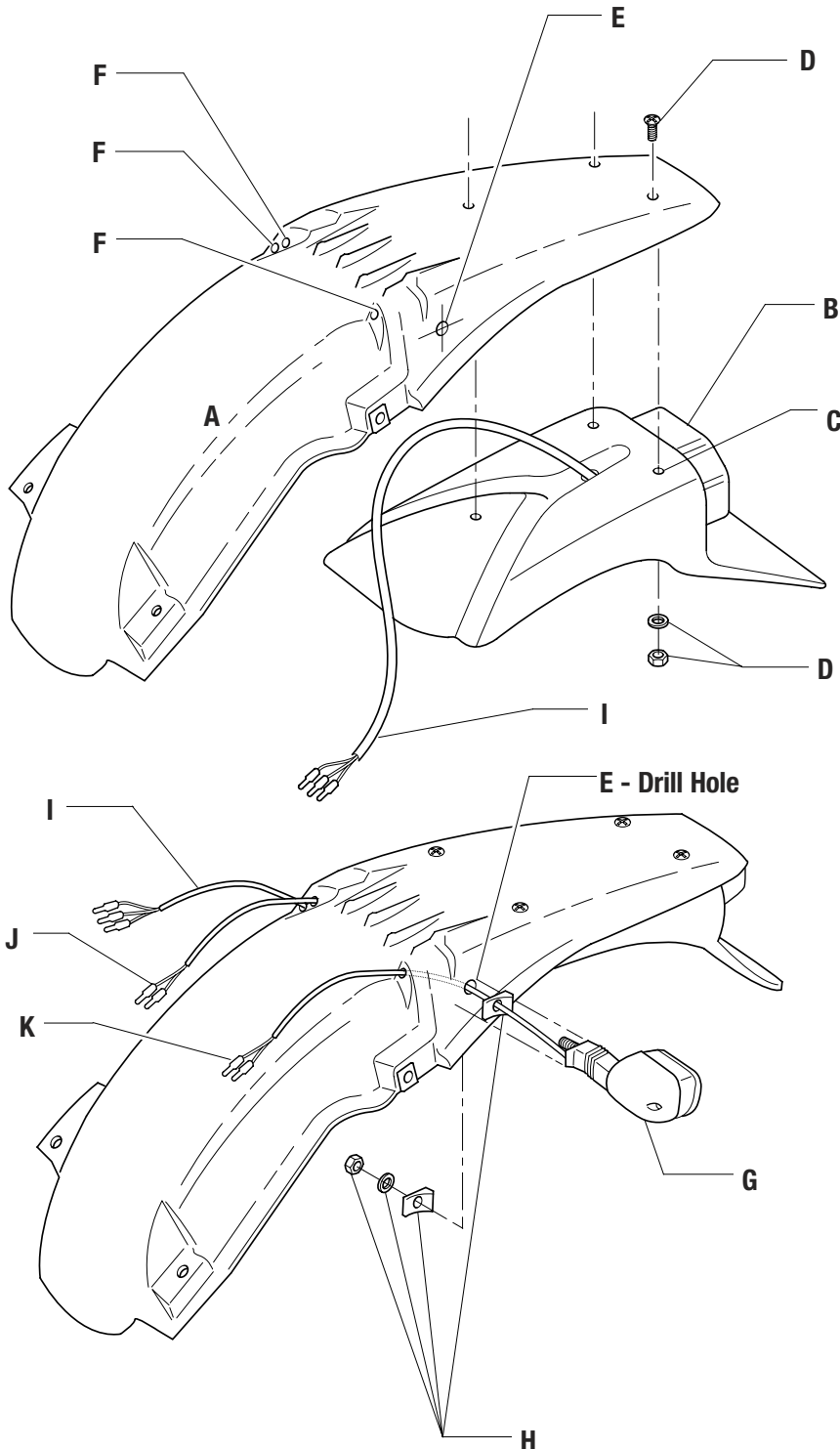

It is suggested that you read through these instructions completely prior to starting the installation. Some drawings shown may differ from your specific bike, however the installation procedure will remain the same.

### Remove Existing Parts

Remove the KLX black taillight LED and wiring, existing seat, front number plate, radiator covers, fuel tank, side number plates and rear fender. Please refer to your owners manual for detailed dis-assembly instructions for each item.

### Taillight Assembly

**Note:** KLX's require removal of the four tabs used to mount the old tail light. Place the rear fender (A) upside down on a clean work surface and position the rear tail light (B) on the inside of the fender. The tail light should rest slightly under the rear edge of the fender.

Using the new DOT legal rear tail light's four mounting holes (C) as guides, trace around each hole with a felt tip marker on the underside of the fender creating drill hole locations. Remove the tail light and drill four 1/4 inch holes. Reposition the tail light, and fasten with supplied screws, washers and nuts (D) as shown.

### Turn Signal Mounting

#### Step 1

Position the rear turn signals by visually lining up the signals (G) behind the rear seat, when its attached to the sub-frame. Care should be observed to insure signals do not interfere with the rear silencer. The signals must mount free and clear of exhaust heat in order to prevent damage to the signal.

Once you have found a suitable location for the signal mounting hole (E), mark and drill one 3/8 inch hole through each side.

#### Step 3

Feed the tail light wiring (I) through the hole and then the turn signal wiring (J). Secure turn signal with supplied alignment wedges, washer and nut (H). Attach second turn signal following same procedure and complete by reinstalling rear fender on bike.

*Note: There may be differences in the instruction manual drawings and the actual parts.*

**TURN SIGNAL RELAY, WIRING HARNESS ROUTING AND KILL SWITCH MODIFICATION**

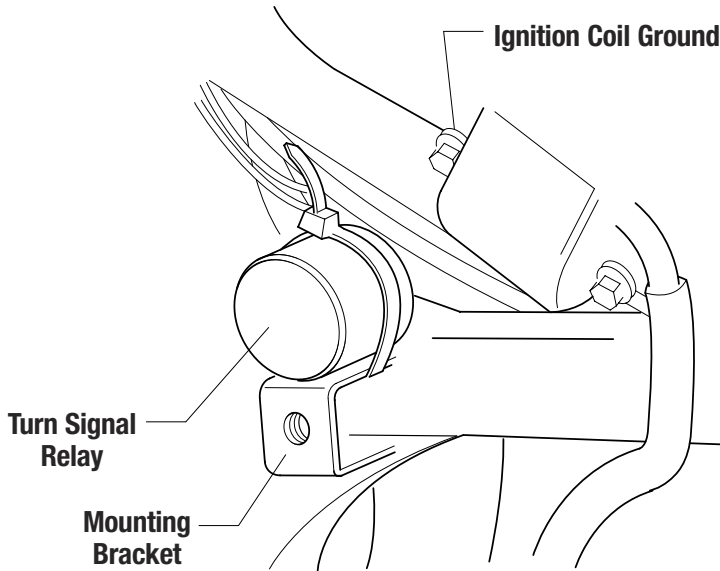

**Turn Signal Relay**

**Step 1**

From the new Dakar wiring harness, connect the WHITE and the BROWN female connectors into either of the signal relay spade connectors.

**Step 2**

locate the relay on top of the fuel tank mounting bracket, near the radiator. The relay connector spades should face inboard. Then, loop a cable tie through the bracket and securely tighten the relay to the bracket.

**Wiring Harness**

Slide the Dakar harness from the front of the triple clamps, through the clutch lever side of the bike. The white block connector should be facing to the front.

**Ground Connections**

Unscrew the forward ignition coil ground screw and position two BLACK ring terminal grounds from the Dakar wiring harness onto the ignition coil ground and fasten with the previously removed screw.

**Kill Switch Modification**

From the handlebar side of the existing kill switch, cut the plug off about 4 inches from the end.

Then take the plug end of the connector and strip the BLACK/YELLOW wire bare and slide the plastic sleeve over the wire and crimp the connector into place. The other BLACK/WHITE wire from the plug is no longer used.

From the Dakar wiring connect the BLACK/WHITE male into the new BLACK/YELLOW female and slide the sleeve over both connectors.

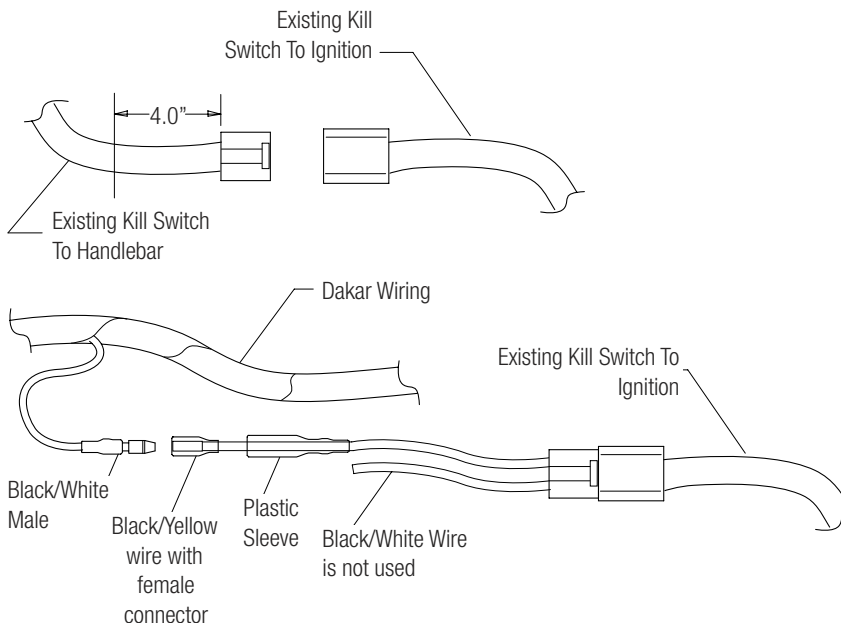



**TAILLIGHT AND TURN SIGNAL CONNECTION**

**Cable Routing Harness Location**

Feed the main wiring harness through the frame on the KLX's clutch side. For installation reference, stick the wiring connection decal on the rear fender, below where the seat will cover it up.

**Taillight Connection**

Connect the WHITE tail light male to the GRAY female connector. Connect the BROWN tail light male ground to the BLACK female connector as shown.

**Turn Signal Connections**

Connect both BLUE tail turn signal grounds into the dual BLACK female ground connector. Connect the ORANGE female into the LIGHT BLUE male (right turn signal) connector, and the PINK female, into the LIGHT BLUE male, (left turn signal) connector.

**Note**

Be sure to carefully and fully seat the connectors into position.

**Secure Cable Ties**

Use a few cable ties along the sub frame to hold the harness into position. Make sure that you secure the harness to frame areas that will not bind or crimp the harness.

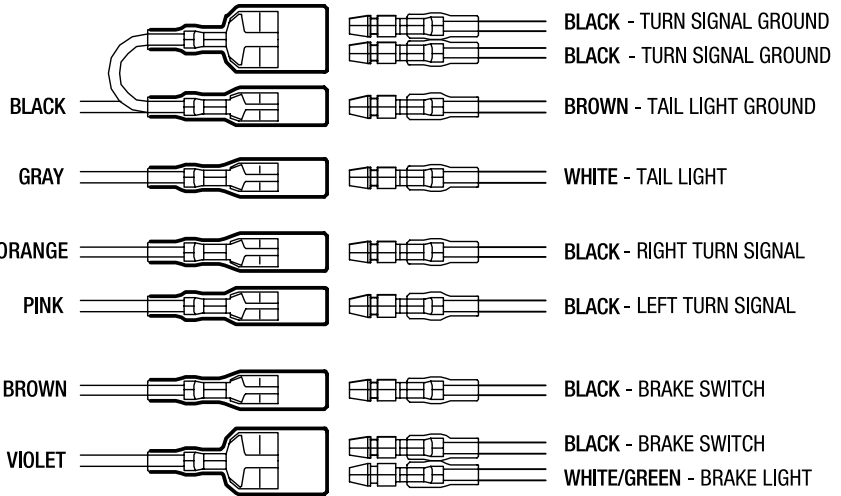
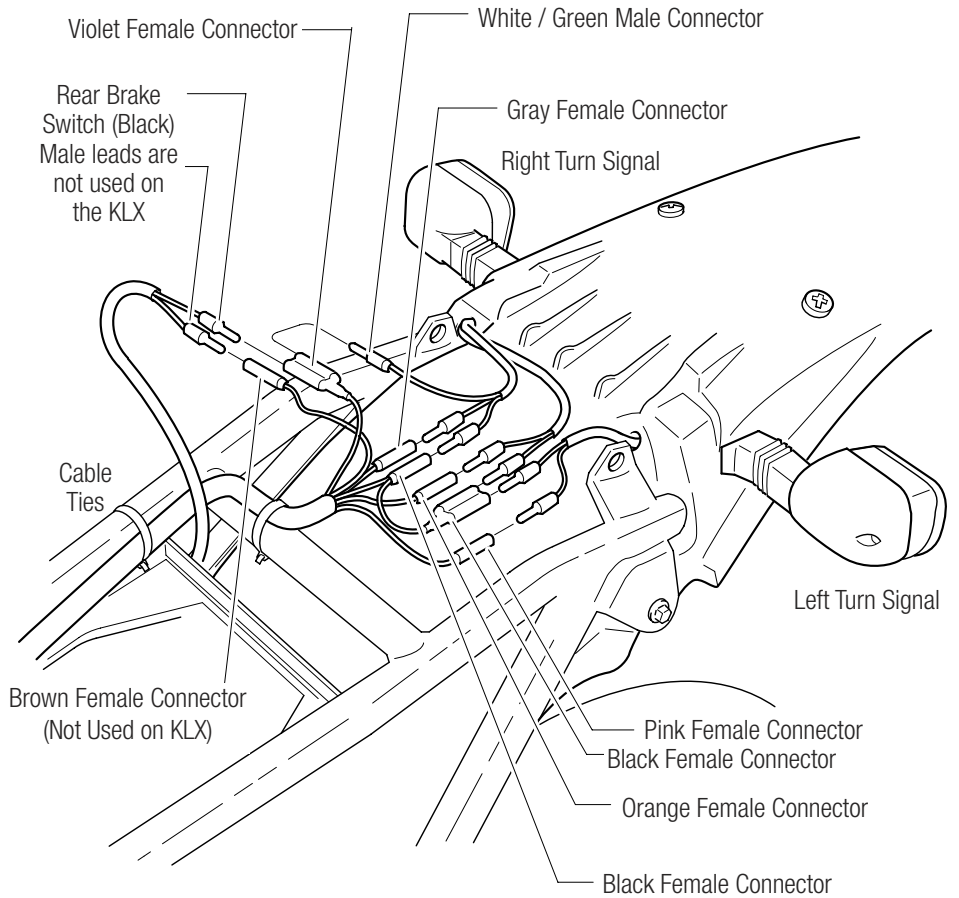

## **HEADLIGHT BEAM ANGLE ADJUSTMENT**

### **Attaching The Headlight**

After the wiring harness has been securely fastened and the complete system has been tested, you can now tilt the top of the headlight into the riding position and fasten the top headlight bracket to each side of the triple clamp.

### **IMPORTANT**

Now start your bike up and go show your friends!

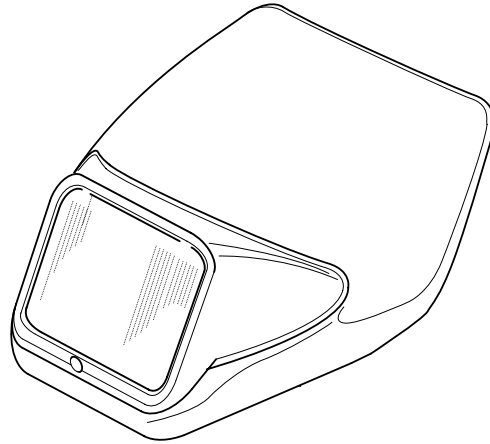



## **Overview**

Vehicle registration policies in most states typically allow conversion of an off-road only title into a street title or in some states a designated "Dual Registration." To register a dirt bike for street use, it must be equipped with the necessary lighting and other equipment required by your state's vehicle code.

### **Every state requires what is called "The Federal Minimum Requirement" which consists of:**

- Headlight with a high and low beam
- Headlight indicator light visible to the operator to show when the high beam is operating
- Horn - Some states mandate an electric horn
- Battery powered taillight and brake light which must operate for 20 minutes on battery power alone
- Rear view mirror
- Turn signals for motorcycles manufactured after 1/1/73 (Most States)
- Some states require speedometers and odometer's
- Tires should be DOT approved
- Lights should be DOT approved
- Fuel tank should be DOT approved\*

\* *Even though the Federal Motor Vehicle Safety Standard specifies steel gas tanks for street motorcycles, most states will not enforce this for converted dirt bikes*

### **Registration procedures vary from state to state but typically involve:**

- Signing two "Statement of facts" certifying that your bike meets state/federal standards.
- Bringing the bike to the DMV or (AAA Insurance Office) for an inspection for proper lighting
- Once the paper work and inspection are complete the final step is to exchange your off-road title for a street title

### **Exchanging your title**

Most states have a "Dual Registration Form" You should be able to download this form from your states DMV over the internet or filling it out at your DMV office. Then pay the transfer fee and obtain your registration, put the plate on your bike and go show your friends!

## **Nothing Happens When You Turn the Power Switch On**

### Possible Causes

- Fuse is blown. Check for bare wire or terminal shorting against the frame or another wire.
- Multi-pin connector not properly connected to the circuit board.
- Poor battery connection. Make sure the connectors are fully seated.
- Battery is flat. Measure voltage with voltmeter, or connect a 12 volt light across it. A fully charged battery will measure between 12.9 and 13.2 volts.
- Poor connection at the blue wire junction above the shock.

## **Headlight does not work on high beam or low beam:**

### Possible Causes

- Check the bulb. Usually one of the bulb filaments is bad, so replacing it will fix the problem. Make sure you replace the bulb with the exact same wattage.
- The handlebar switch is dirty inside. Clean it out with some WD40.

## **Headlight is dim at idle:**

### Possible Causes

- Increase the idle speed a little. Dual sport setups work a lot better if the idle speed is a bit "on the high side". This is due to the design of most of the lighting /charging coils, which really start putting out power at around 1200 rpm.
- Battery is not charged. Charge battery using a standard battery charger. Connect the black (negative) lead from the charger to a good frame ground, and connect the red (positive) lead from the charger to the blue lead that connects to the horn. (just slide the blue connector sleeve back, and connect the charger up to the exposed terminal) You do not need to disconnect the horn. Turn key switch to "ON" Position.
- Check bulb wattage. Certain kits come with a lower wattage bulb than a standard H4 bulb. ElectroSport has all bulbs in stock.

## **Taillight does not work:**

### Possible Causes

- Check the bulb. Due to vibration the bulb could have gone out. Check the connections in the bulb holder as well, water could oxidize the contacts, preventing the bulb from coming on.
- Check the connections, especially the ground under the seat. You'll find a gray wire (taillight positive), a black wire (taillight and brakelight ground) and a violet wire (=purple, brake light positive). Check these connections carefully.



### **Brake light stays on:**

#### Possible Causes

- unplug the brake light switches one by one. If one of the switches is bad, it will close its contacts and leave the brake light on. The brake light switch that makes the brake light turn off as soon as you unplug it, is bad.

### **Brake light does not work:**

#### Possible Causes

- Check the bulb. Due to vibration the bulb could have gone out. Check the connections in the bulb holder as well, water could oxidize the contacts, preventing the bulb from coming on.
- Check the connections, especially the ground under the seat. You'll find a gray wire (taillight positive), a black wire (taillight and brakelight ground) and a violet wire (=purple, brake light positive). Check these connections carefully.

### **Blinkers don't work:**

#### Possible Causes

- Battery is not charged. Charge battery using a standard battery charger. Connect the black (negative) lead from the charger to a good frame ground, and connect the red (positive) lead from the charger to the blue lead that connects to the horn. (just slide the blue connector sleeve back, and connect the charger up to the exposed terminal) You do not need to disconnect the horn. Turn key switch to "ON" Position.
- flasher relay is bad. Replace with new one.

### **Blinkers don't work at idle, or flash intermittently:**

#### Possible Causes

- Battery is not charged. Charge battery using a standard battery charger. Connect the black (negative) lead from the charger to a good frame ground, and connect the red (positive) lead from the charger to the blue lead that connects to the horn. (just slide the blue connector sleeve back, and connect the charger up to the exposed terminal) You do not need to disconnect the horn. Turn key switch to "ON" Position.
- increase the idle speed a little. Dual sport setups work a lot better is the idle speed is a bit "on the high side". This is due to the design of most of the lighting /charging coils, which really start putting out power at around 1200 rpm.

### **Horn doesn't work:**



Possible Causes

- Battery is not charged. Charge battery using a standard battery charger. Connect the black (negative) lead from the charger to a good frame ground, and connect the red (positive) lead from the charger to the blue lead that connects to the horn. (just slide the blue connector sleeve back, and connect the charger up to the exposed terminal) You do not need to disconnect the horn. Turn key switch to "ON" Position.
- Adjust small set screw on the back side of the horn. Turn it both ways until you get a nice loud "honk"

**Lost key while riding:**

Possible Causes

- The Dakar setup will perform fine, but you'll have to top up the battery regularly (weekly) to prevent it from going flat. Call ElectroSport for a replacement.

**Kill button does not work:**

Possible Causes

- Ensure that the black/white wire of the wiring harness is plugged in correctly.
- If the kill button does not work, but turning the key switch does kill the engine, you have a dirty handlebar switch. Spray inside it with WD40.

**Technical Support Contact Information**

ElectroSport Industries  
3803 Oceanic Dr. Ste 201  
Oceanside CA 92056  
PH: 760-842-8300 (9-5 M-F PST)  
WEB: [www.electrosport.com](http://www.electrosport.com)  
email: [Info@electrosport.com](mailto:Info@electrosport.com)